

BEGANE GROND

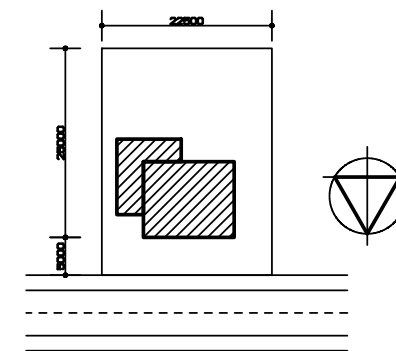

SITUATIETEKENING
SCHAAL 1:1000

DE PASSIEFHUISBOUWER
Duwo-Comfort passiefhuis multistijlontwerp model "Gaia"
schaal: 1/100, blad: 01

Bergerweg 20
1862 Jv Bergen
T: 072-5895745
E: info@admiralstoute.nl
I: www.admiralstoute.nl



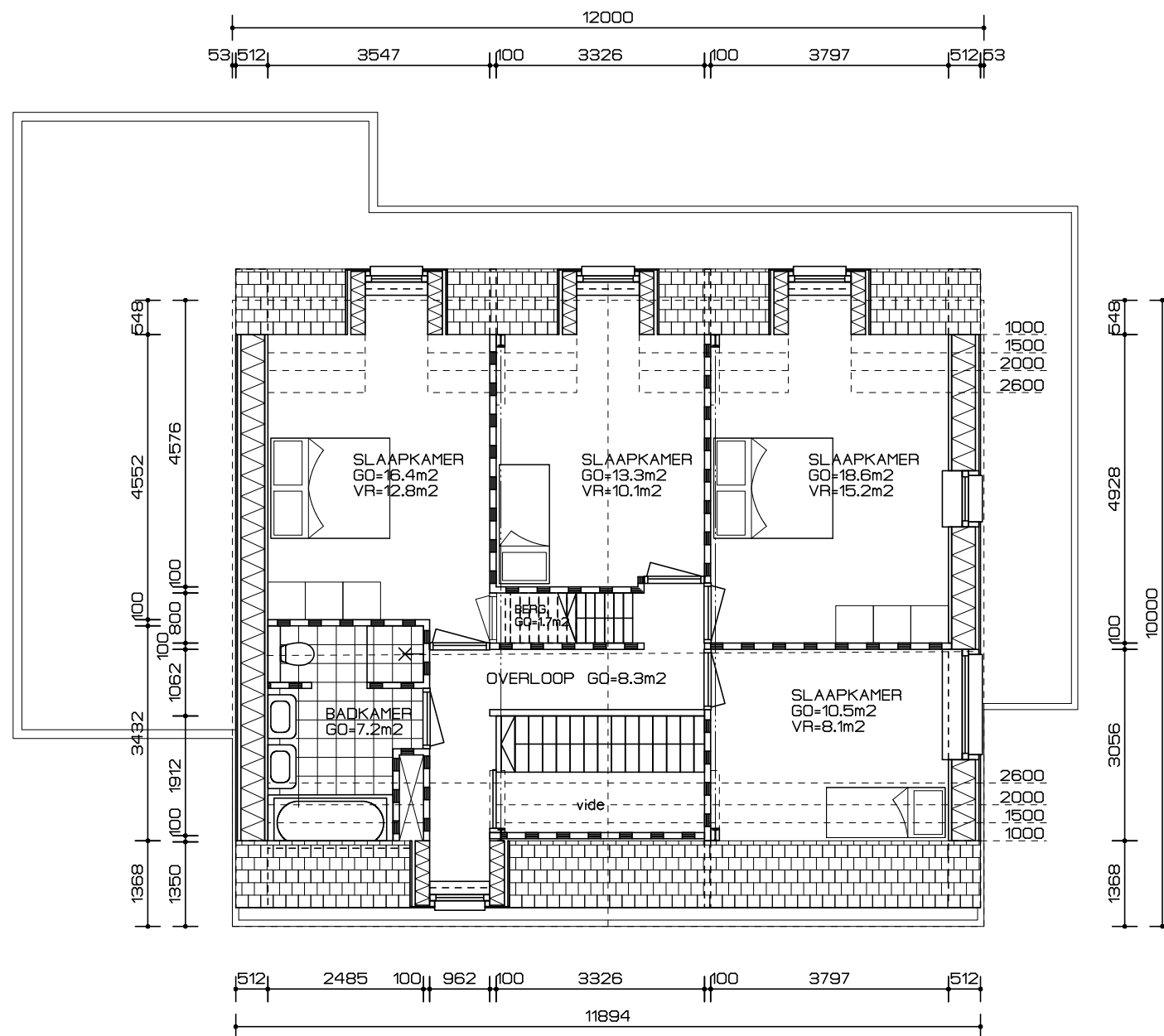

EERSTE VERDIEPING

	HOOFD-GEBOUW	BIJ-GEBOUW	TOTAAL
BEBOUWD OPPERVLAK	120m ²	41.5m ²	161.5m ²
BRUTO VLOEROPPERVLAK			
- begane grond	119.6m ²	41.5m ²	
- verdieping	121.3m ²	-	
- zolder	81m ²	-	
totaal	321.7m ²	41.5m ²	363.2m ²
INHOUD	823.7m ³	132.8m ³	956.5m ³

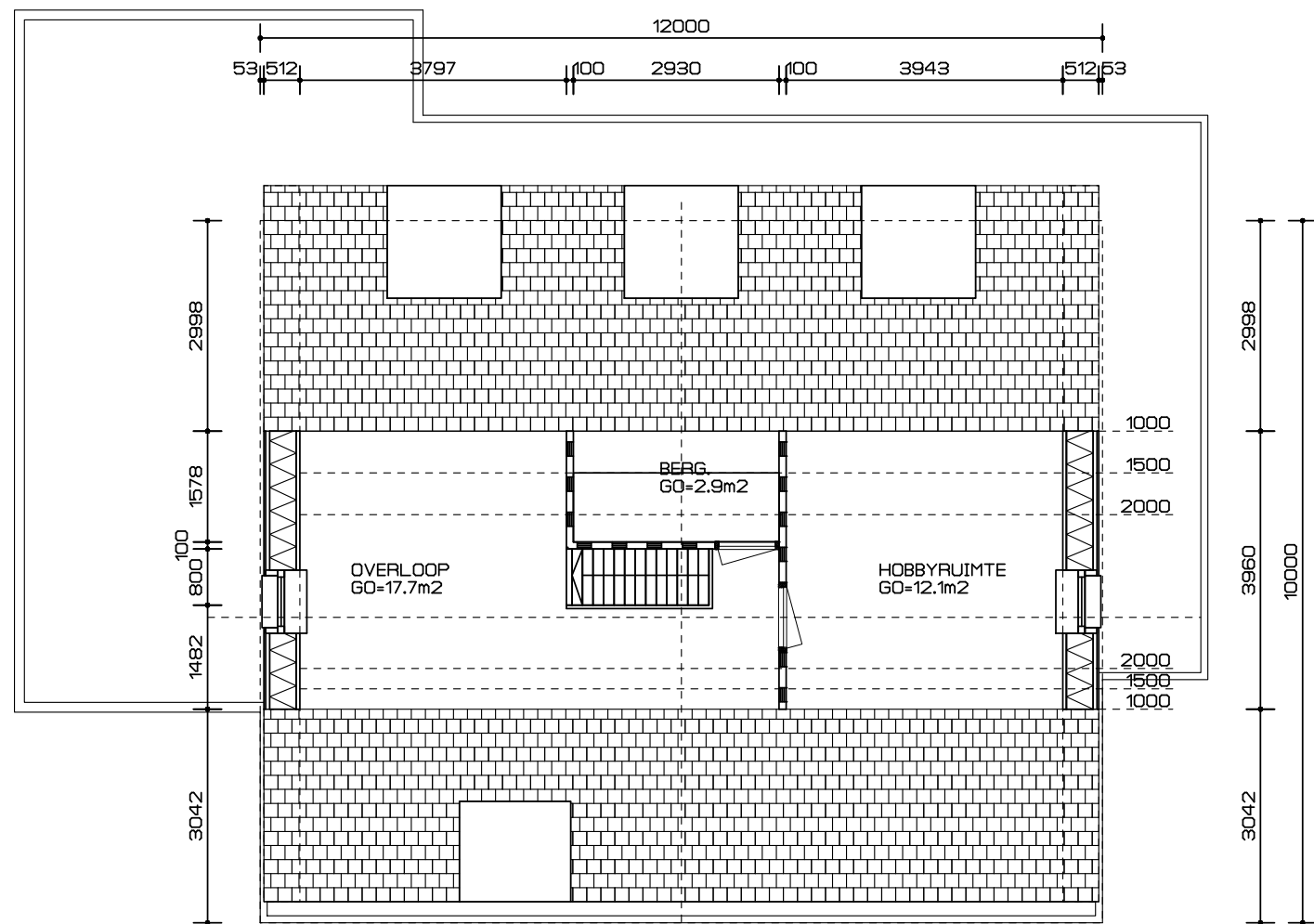

ZOLDER

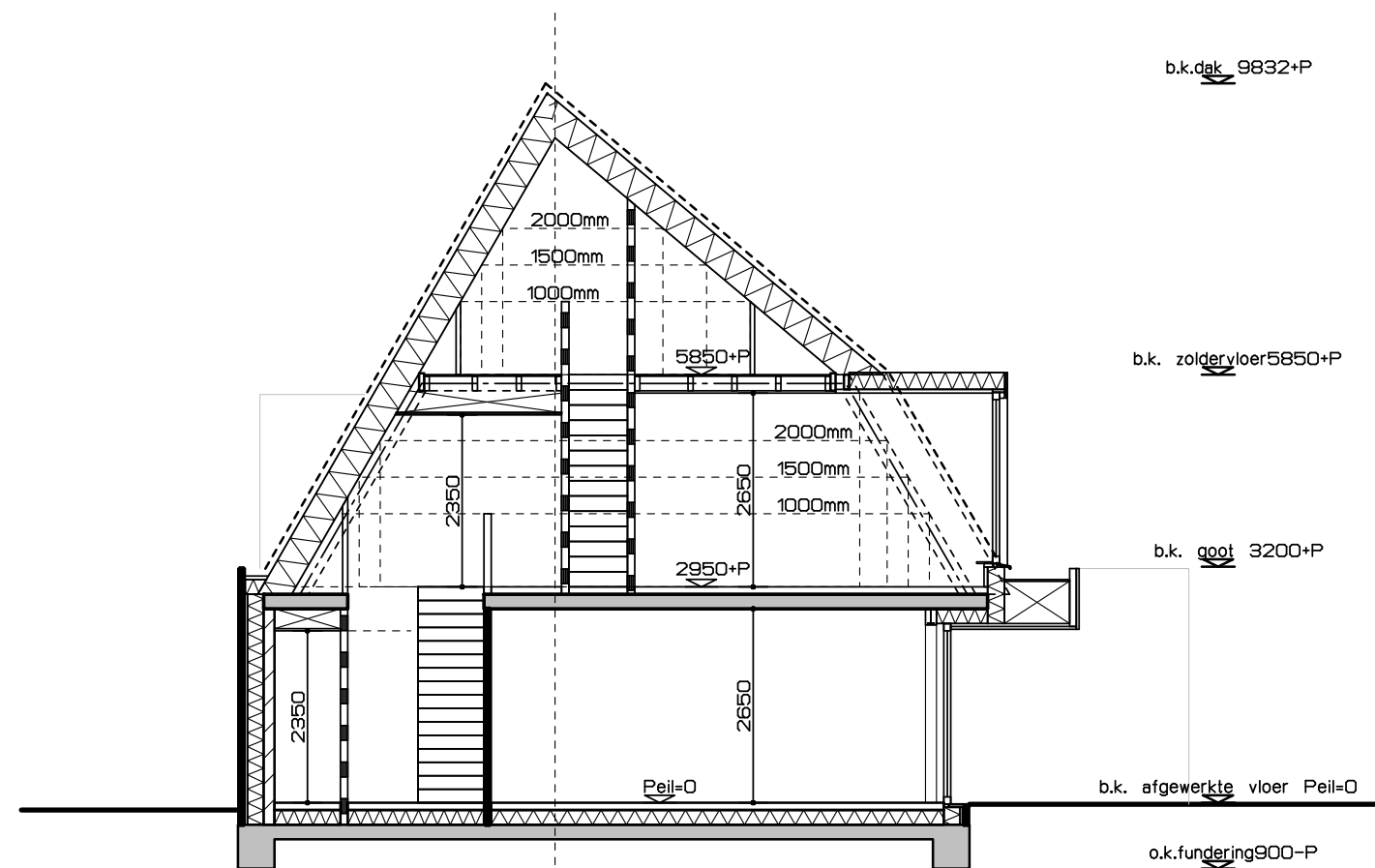

DWARSDOORSNEDE

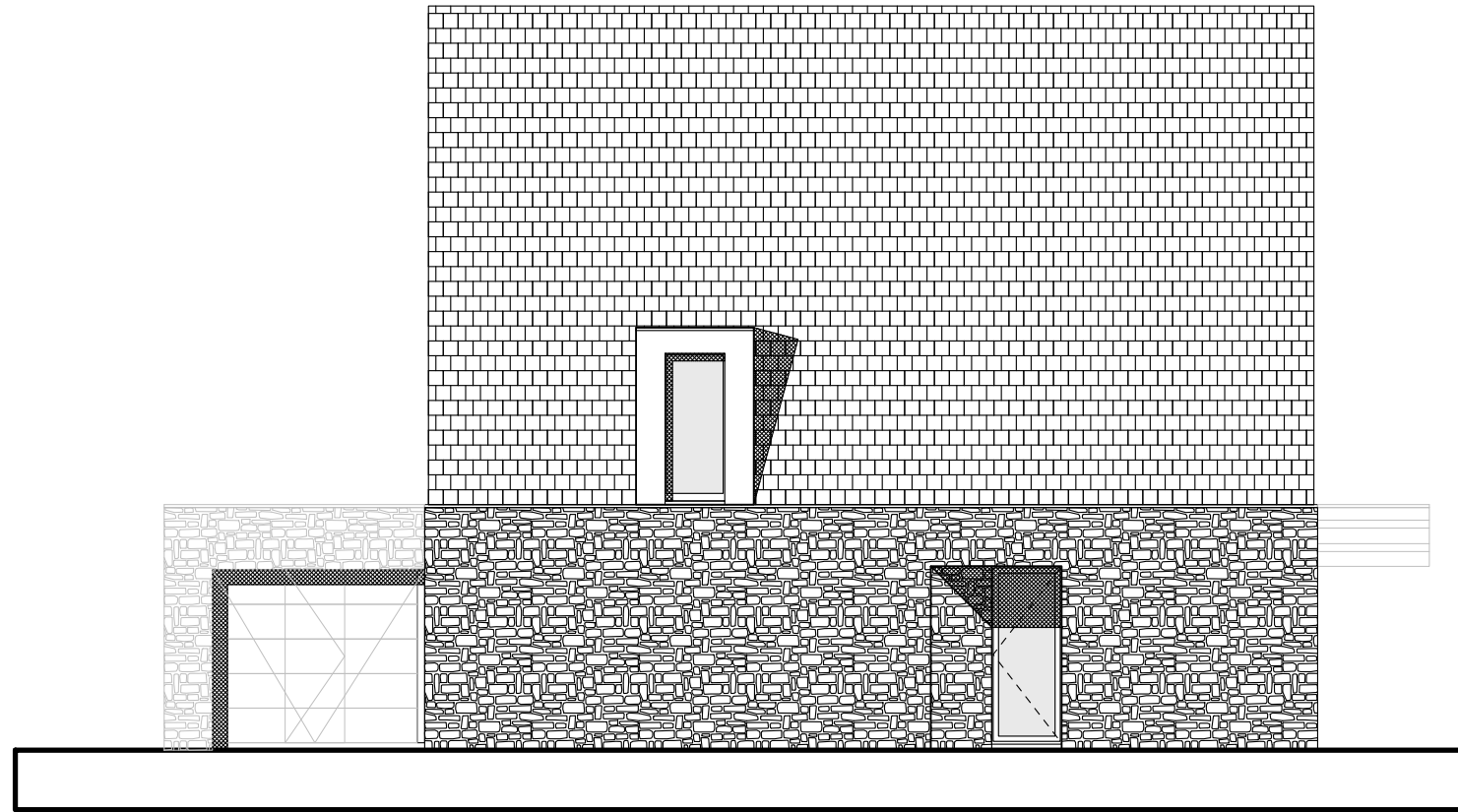

VOORGEVEL (noord)

onderdeel	materiaal
gevel	Metselwerk, diverse formaten
kozijnen	kunststof, merk: internorm, type: thermo 3
boeideel	houten delen, open gevelsysteem, diverse formaten, gebeitst
balkonhekken	veiligheidsglas
dakbedekking	red ceder shingles, onbehandeld bitumen (platte daken)



RECHTER ZIJGEVEL (west)

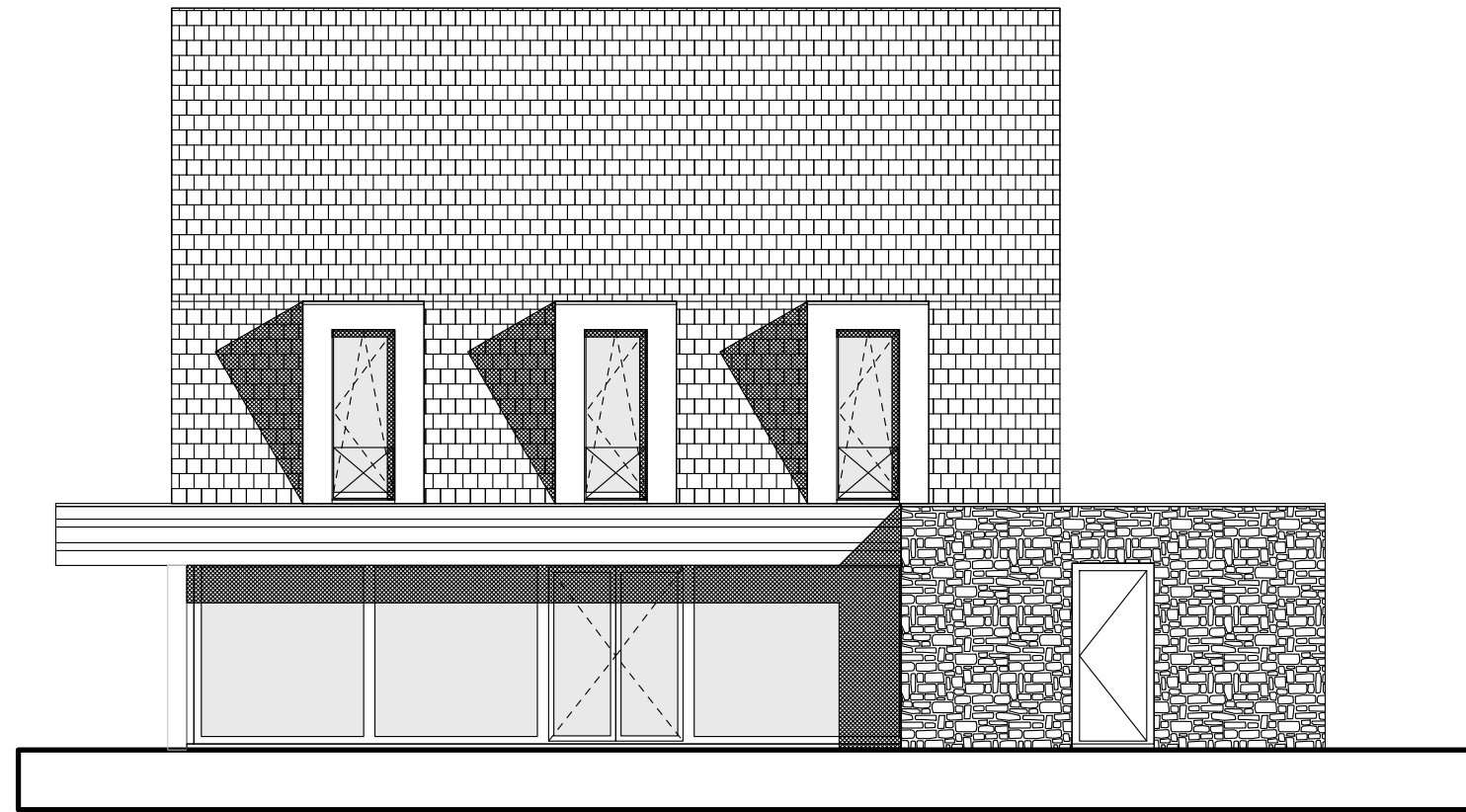

ACHTERGEVEL (zuid)

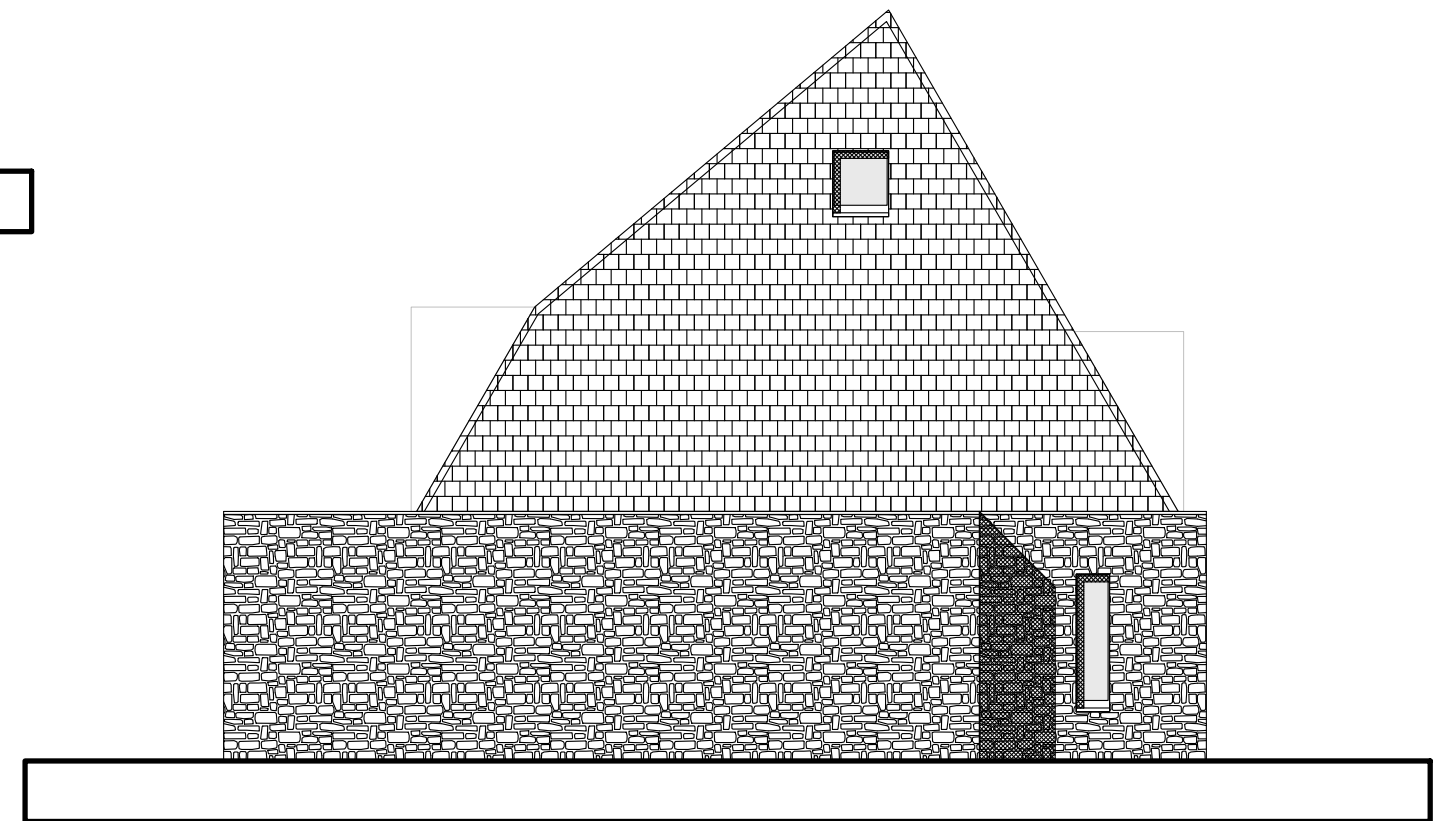

LINKER ZIJGEVEL (oost)